

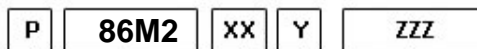

### #PTO POS. M. D. MERCEDES G240 (ACTROS)

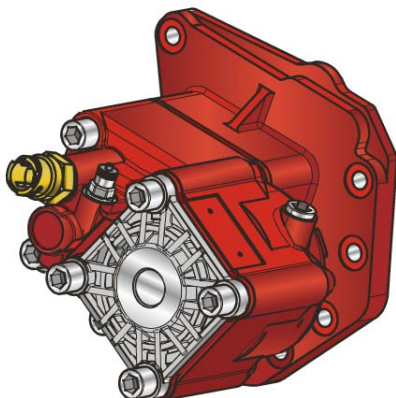

Outlet version  
Available option  
Control option  
Model  
PTO

	<b>Output 1</b>		<b>Number of teeth</b>	12
<b>Torque (Nm)</b>	400		<b>Module</b>	3
<b>Int. ratio</b>	1,58		<b>Replace</b>	
<b>Number of axles</b>	2		<b>Replaced by</b>	

15/02/2011

### Command type

Electric     Hydraulic     Mechanical     Fixed engagement     Pneumatic     Vacuum system

